



# AltRider High Fender Kit for Honda Africa Twin CRF1000L INSTALLATION INSTRUCTIONS

The most up to date instructions can be downloaded from the product page at [altrider.com](http://altrider.com), under the instructions tab.

Dear Rider,  
Thank you for choosing AltRider! Whether a seasoned world adventurer or a first time ADV-Newbie, we welcome you to the AltRider experience. You can install your new product with the utmost confidence. AltRider designs, tests, and manufactures all of its products here in the United States. We are proud to do what we do, and honored to present to you the product of our labors.

Enjoy it, show it off, and most of all, **RIDE IT!**

Venture On,  
Jeremy LeBreton



## AltRider High Fender Kit Honda Africa Twin CRF1000L AT16-X-8102

- Package Contents:
- Fender
  - Bracket
  - Fork Leg Guards
  - Brake Hose Kit for bikes with ABS
  - Hardware Kit
  - Instructions

## AltRider High Fender Kit Honda Africa Twin Adventure Sports AT18-X-8102

- Package Contents:
- Fender
  - Bracket
  - Fork Leg Guards
  - Brake Hose Kit for bikes with ABS & double banjo bolt
  - Hardware Kit
  - Instructions

### AltRider LLC

#### Global

mailing: 4000 Aurora Ave N Ste 100  
Seattle, WA 98103 USA  
phone: 206-922-3618  
email: [info@altrider.com](mailto:info@altrider.com)  
web: [www.altrider.com](http://www.altrider.com)

#### Europe

mailing: AltRider EU  
Heliumstraat 230  
2718 RS Zoetermeer  
The Netherlands

email: [info@altrider.eu](mailto:info@altrider.eu)  
web: [www.altrider.eu](http://www.altrider.eu)

MADE IN THE USA  
REV 2

### AltRider LLC

#### Global

mailing: 4000 Aurora Ave N Ste 100  
Seattle, WA 98103 USA  
phone: 206-922-3618  
email: [info@altrider.com](mailto:info@altrider.com)  
web: [www.altrider.com](http://www.altrider.com)

#### Europe

mailing: AltRider EU  
Heliumstraat 230  
2718 RS Zoetermeer  
The Netherlands

email: [info@altrider.eu](mailto:info@altrider.eu)

REV 2  
MADE IN THE USA



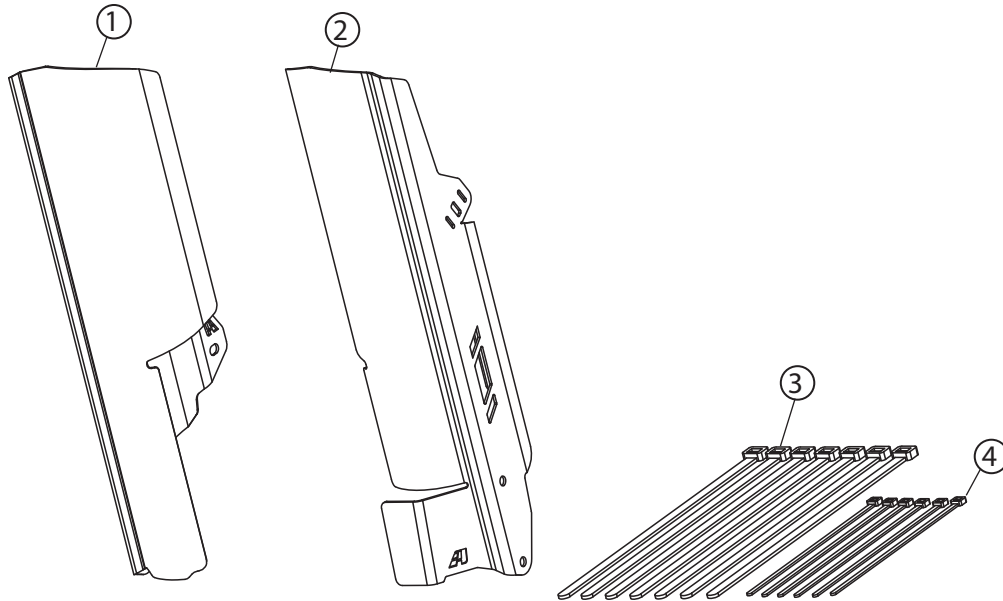

#### Fork Leg Guard Kit:

- ① Right fork leg guard
- ② Left fork leg guard
- ③ (qty 7) heavy duty nylon ties
- ④ (qty 6) standard nylon ties

NOTE: If you purchased stand-alone fork leg guards this is the entire kit. Instructions are on page 3.

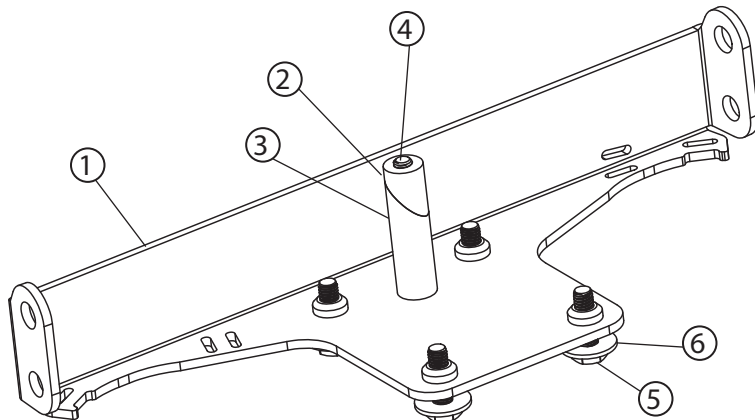

#### High Fender Bracket Kit:

- ① High fender bracket
- ② Threaded spacer with angled end
- ③ Long unthreaded spacer with angled end
- ④ M6 x 50 stainless steel flat head screw
- ⑤ (qty 4) M6 x 20 stainless steel hex cap screw
- ⑥ (qty 4) M6 stainless steel large diameter washer



**Brake Hose Kit:**

- ① Stainless braided left side brake hose with ABS block fitting and banjo
- ② Stainless steel braided crossover brake hose with two banjo fittings
- ③ (qty 7) Pre-installed rubber grommets
- ④ (qty 5) Sealing washers (crush washers)
- ⑤ Double banjo bolt (ONLY included with Adventure Sports model)

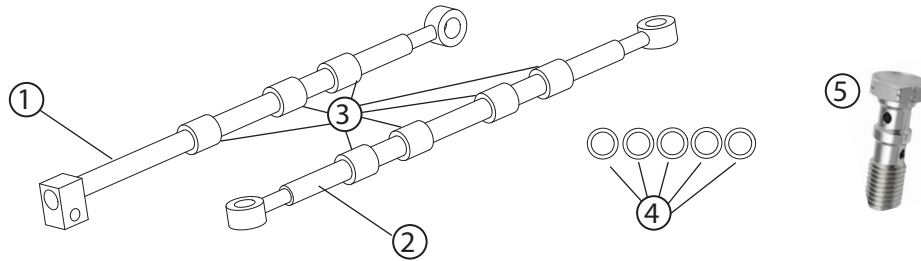

(NOT TO SCALE)

**Fender Kit:**

- ① Fender
- ② Adapter plate

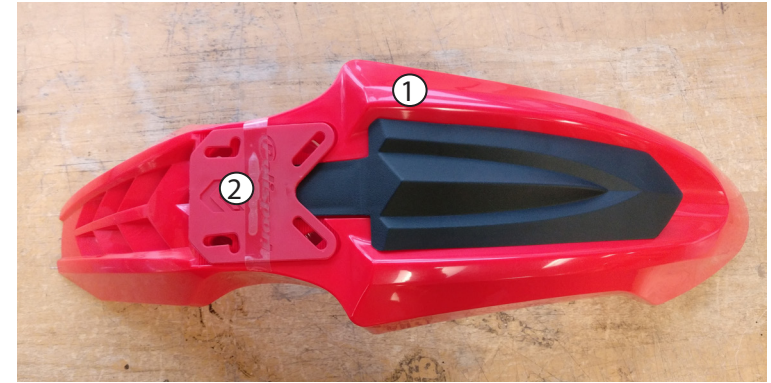
**Tools:**

- ① 8mm socket
- ② 10mm socket
- ③ 12mm socket
- ④ extension
- ⑤ 8mm spanner
- ⑥ 10mm spanner
- ⑦ 5mm hex wrench
- ⑧ 4mm hex wrench
- ⑨ Torque Wrench
- ⑩ Ratchet
- ⑪ Phillips screwdriver
- ⑫ Medium strength thread locker

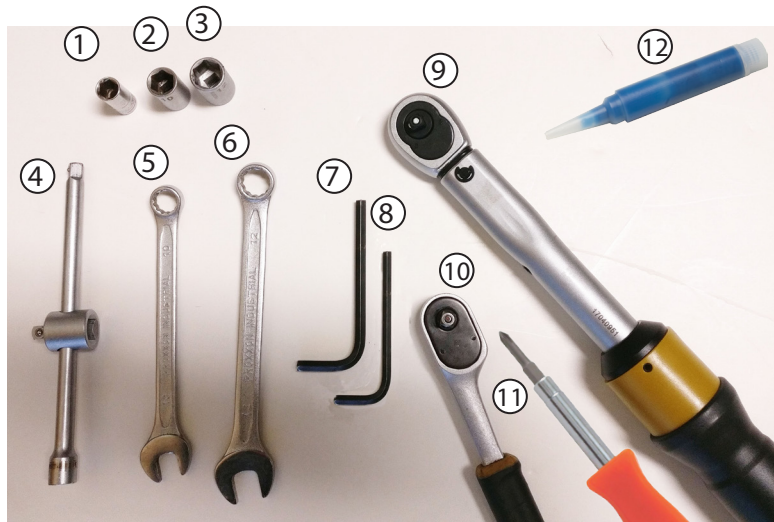
**Brake Bleed Kit:**

- ① Drain Pan
- ② Brake Fluid
- ③ Rags
- ④ Brake Cleaner
- ⑤ Hose





**NOTE: Stand-Alone Fork Leg Guards:** Refer to this page  
**High Fender Kit:** Instructions start on page 4

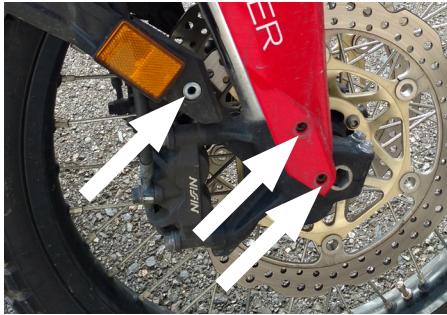

- ① If you have any hesitations please consult a professional mechanic to complete this installation. Use 5mm allen tool to remove screws and shoulder spacers (qty 6 each) from OEM front fenders. Save these, you will use them later.

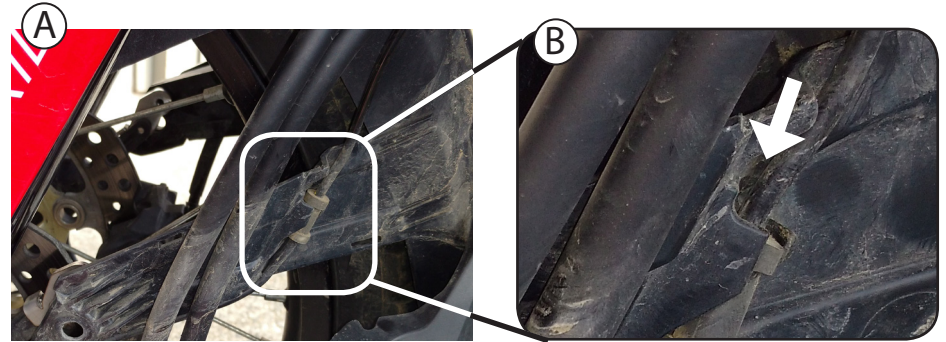

- ② (A) Unclip the side covers on both sides. (B) Unclip the ABS wire.

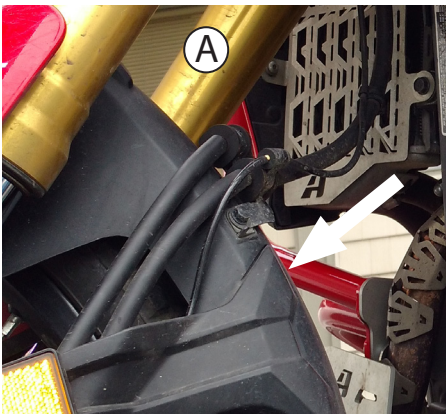

- ③ (A) Unscrew the brake hose bracket on top of the fender.



- ④ Install right fork leg guard. Use the original M6 button head screws and the original shoulder ("hat") spacers. Arrange the spacers with the wider part against the AltRider fork leg guard.

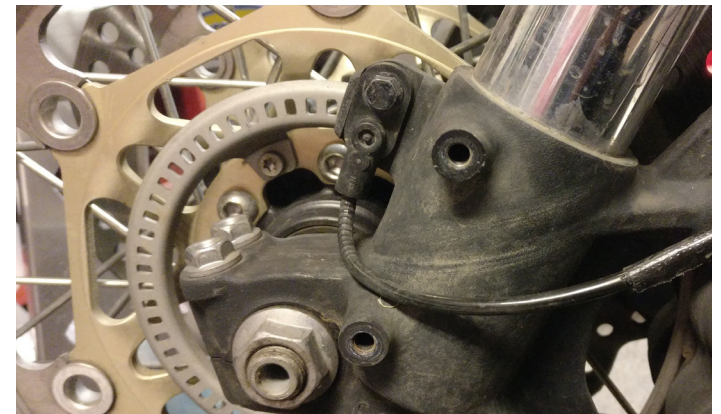

- ⑤ Install left fork leg guard. Be sure to route the ABS line as shown. Use the original M6 button head screws and the original shoulder ("hat") spacers. Arrange the spacers with the wider part against the AltRider fork leg guard.

**Removing the OEM front fender also removes some of the brackets for front brake line routing. It is up to the user to secure and route the brake lines appropriately.** The AltRider high fender kit comes with everything needed, see our website for more information. [www.altrider.com](http://www.altrider.com)



- ① If you have any hesitations please consult a professional mechanic to complete this installation. Use 5mm allen tool to remove screws and shoulder spacers (qty 6 each) from OEM front fenders. Save these, you will use them later.

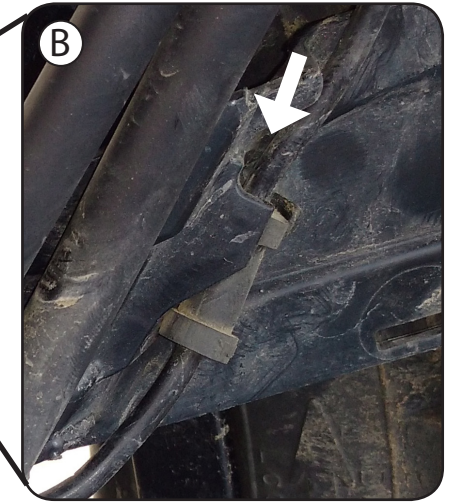

- ② (A) Unclip the side covers on both sides. (B) Unclip the ABS wire.

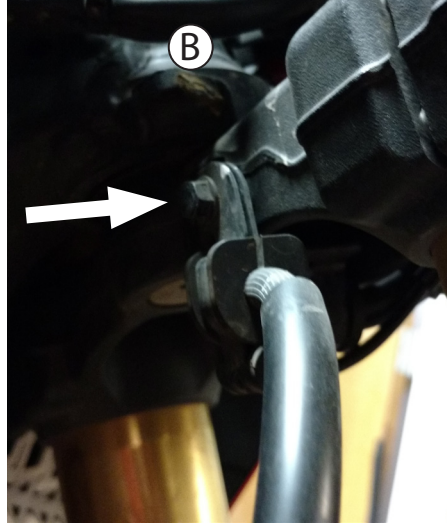

- ③ (A) Unscrew the brake hose bracket on top of the fender. (B) Unscrew the brake hose bracket on the backside of the lower triple tree.

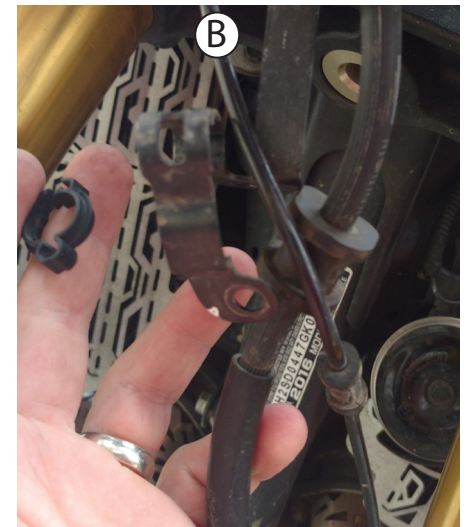

- ④ Unclip the ABS line from the brake hoses and from the fender. Remove the front fender.

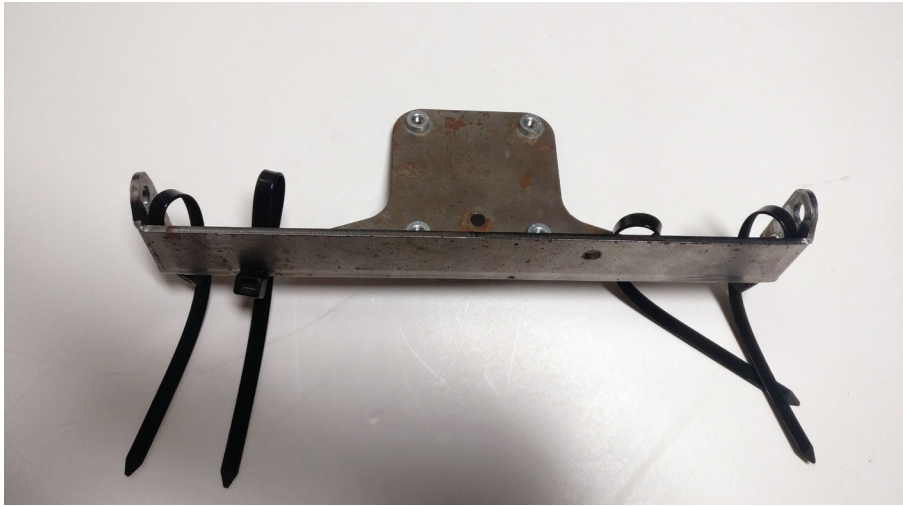

- ⑤ Install heavy-duty nylon ties onto the fender bracket. Be sure to install them in the positions and orientation shown. The heads of the zip ties should be on the outer surfaces of the bracket, so that later when fully installed you can easily access them.

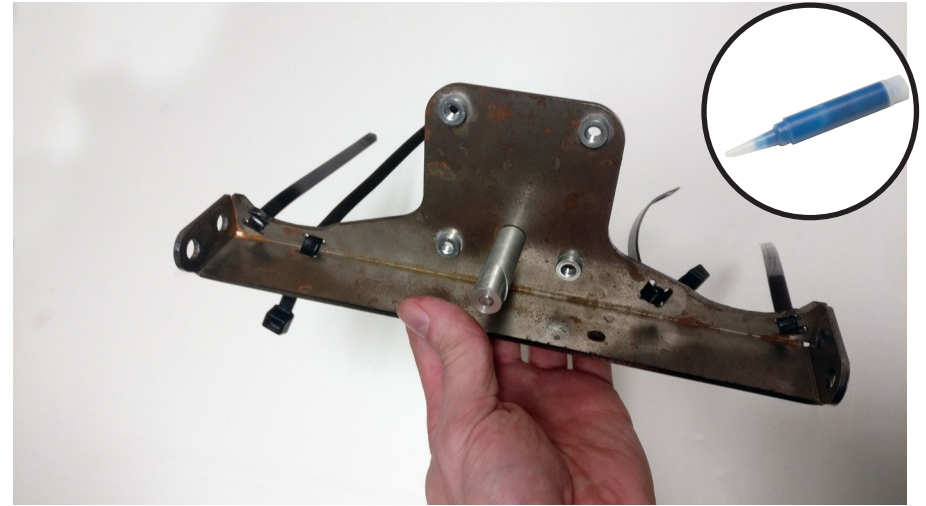

- ⑥ Install the M6 x 50 flat head screw, long unthreaded angled spacer, and shorter threaded angled spacer onto the fender bracket as shown. Use medium-strength thread locker to the threaded angled spacer. Leave the whole assembly loose with space in between two pieces for now.



LEFT SIDE



RIGHT SIDE



- ⑦ Remove the lower bolt of the lower fork tube clamp. One on the left side, one on the right. Save these for reinstallation later.
- ⑧ Slide the AltRider high fender bracket upward partially into place. Next remove the upper two fork leg clamp bolts, one from each side.



- ⑨ Slide the fender bracket fully upward into place, at the same time sliding the angled spacers up inside the fork steerer tube. Reinsert all four fork tube clamp bolts.



If installing on Adventure Sports model  
read steps 10 - 11  
If installing on standard model skip to step 12



- ⑩ When installing on an Adventure Sports model the brackets for the Honda light bar can interfere with the fender if not installed correctly. To avoid interference tilt the front AltRider High Fender Bracket down as much as it will while the four fork tube clamp bolts are inserted, but not tightened.



- ⑪ By tilting the front of the AltRider High Fender bracket down it will change the angle of the fender and will not interfere with the Honda bracket for the light bar. The fender will be installed after routing the brake lines at step #24, this will make securing the brake lines easier.



- ⑫ Tighten fork tube bolts to 25Nm. Tighten the M6 x 50 flat head screw and angled spacers to 4Nm. TIP: If the angled spacers are not tightening use needle-nose pliers to grip the base of the long unthreaded spacer and hold it stationary while tightening the M6 screw.

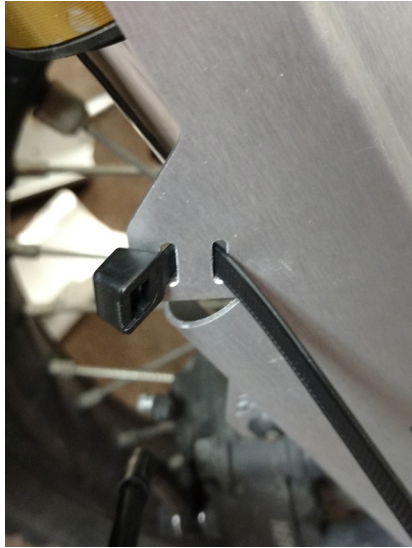

- ⑬ Install heavy-duty nylon ties to the fork leg guards as shown.



- ⑭ Install right fork leg guard. Use the original M6 button head screws and the original shoulder ("hat") spacers. Arrange the spacers with the wider part against the AltRider fork leg guard.

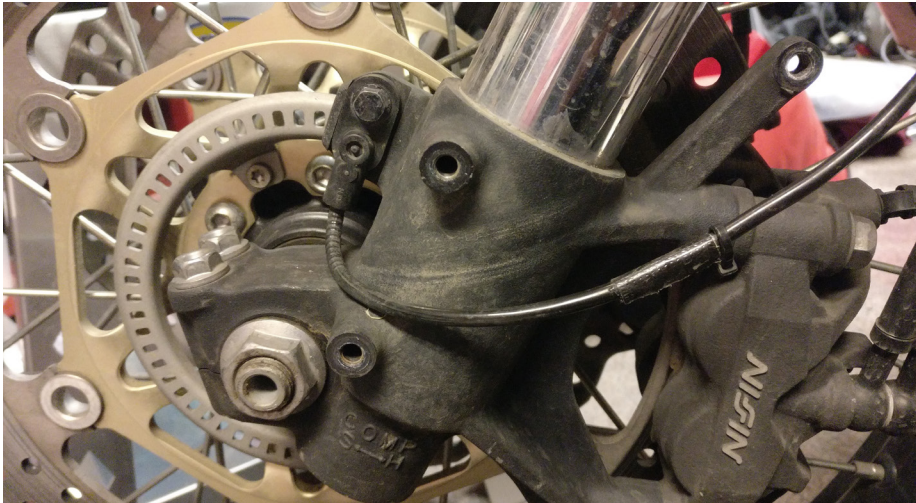

- ⑮ Install left fork leg guard. Be sure to route the ABS line as shown. Use the original M6 button head screws and the original shoulder ("hat") spacers. Arrange the spacers with the wider part against the AltRider fork leg guard.



- ⑯ Prepare for removing OEM brake lines and installing new AltRider brake lines. You will want a drain pan, brake cleaner, brake bleeder kit, and new replacement brake fluid. **IMPORTANT NOTE:** Do not allow the master cylinder to completely drain of brake fluid at any time during the installation. Also, use care when handling brake fluid, as it can quickly damage finished surfaces (paint, plating, etc.)





- ①7 Remove banjo bolts and banjo fittings on right and left caliper. Drain the lines.  
Save the Banjo bolts you will need these later.

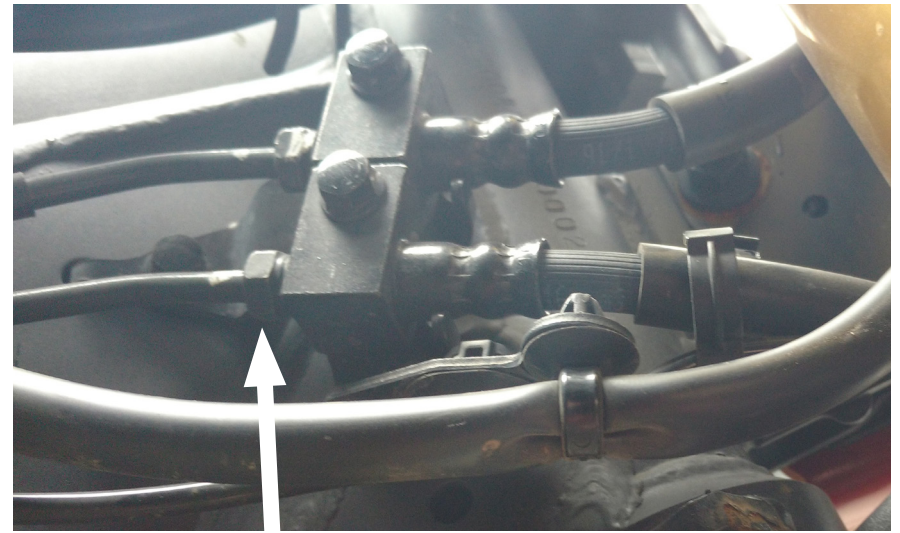

- ①8 Use 10mm spanner, loosen the coupling nut that holds the lower hard line to the block fitting for the front hoses. TIP! The coupling nut is soft metal. Be sure the spanner has a good fit and is square, use small movements if necessary to avoid rounding off this fastener.

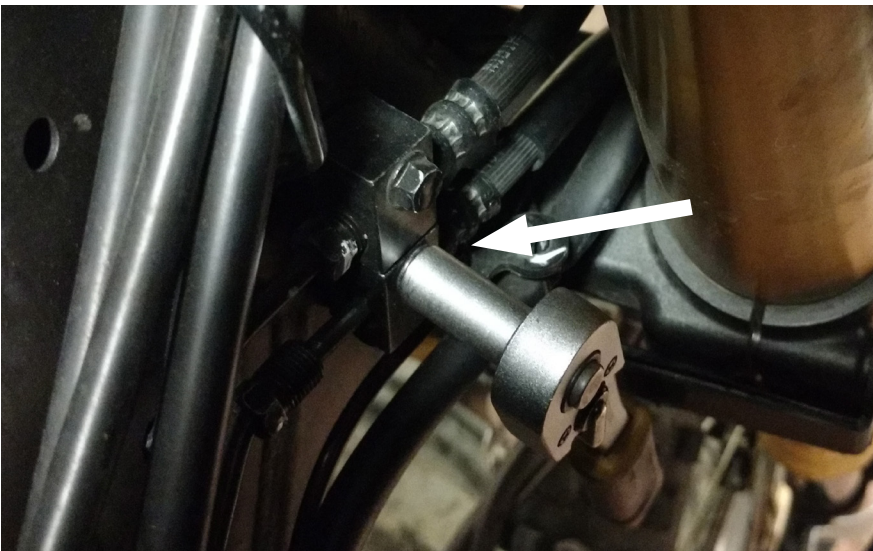

- ①9 Use 8mm socket and remove the screw holding the block fitting. Save this screw for use later. Remove OEM brake hoses.

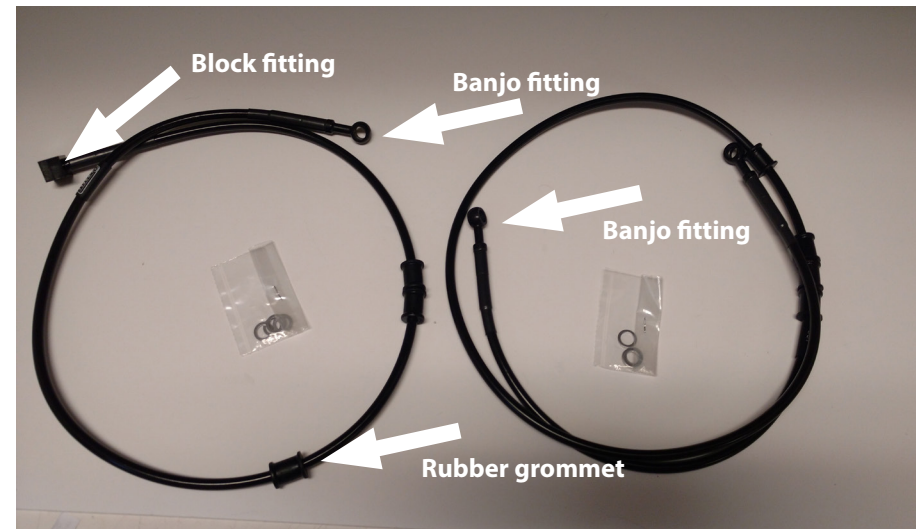

- ②0 Lay out new brake hoses. Note orientation of block fitting, location of rubber grommets. The rubber grommets can be gripped and moved along the hose to optimize their location.



- 21 Place the hose with block fitting located as shown, with the block fitting near the hard line. Note the hose is routed forward over the lower triple tree, along right side of bike. Take care to not pinch the ABS line. Use 5mm screw to attach the block fitting loosely to the frame.

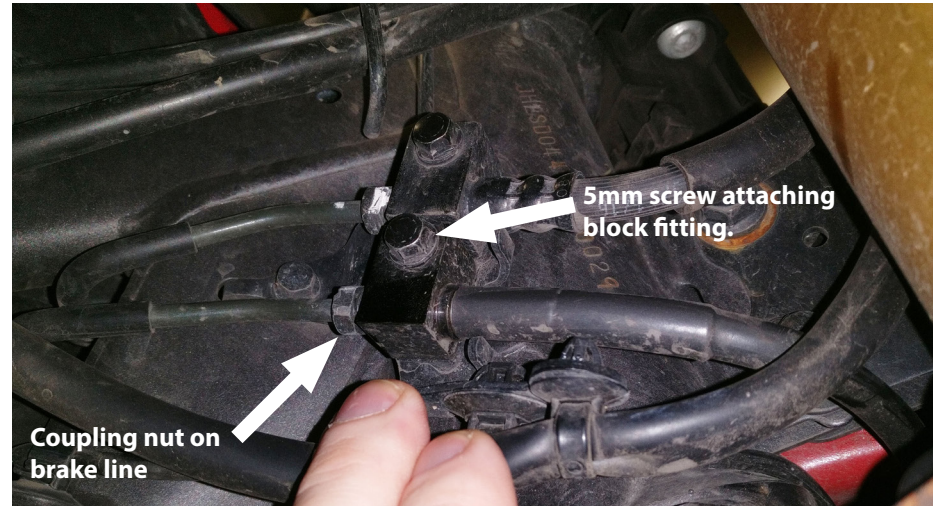

- 22 Use fingers to start threading the coupling nut into the block fitting. Once started, use a 10mm spanner and completely tighten the nut. Use 8mm socket to tighten the screw holding the brake block to the frame.



- 23 Route the brake hose from ABS block fitting to the left caliper. Note the hose is routed in a circuitous way to avoid interference at full steering lock and/or fork compression. From the block fitting the hose comes forward over the lower triple tree (see picture from step #21). Then it bends rearward, under the lower triple tree staying on the rider's right side of the fender bracket. Next the hose curves tightly around the backside of the bracket, bending toward the left fork tube. Leave loose for now. (A) Secure the inner right side zip tie to ABS line and



brake line at grommet on brake line (be sure to place ABS line next to bracket as shown), leave the zip tie loose. (B) Secure the ABS line to the brake line at the ABS grommet with smaller zip tie, leave loose for now. Then route ABS line and brake line down along side the left fork leg guard to the brake caliper. Ensure the hose has no kinks or twists.



- ②4 Arrange the flat adapter plate on top of the fender in location shown. TIP: Use tape to help hold it in the correct position with plastic bracket all the way forward. Apply thread locker to each of the M6 screws.



- ②5 Use four (4) M6 screws with thread locker, and four(4) washers. Install the fender to the fender bracket. Be careful not to over tighten plastic fender and bracket.

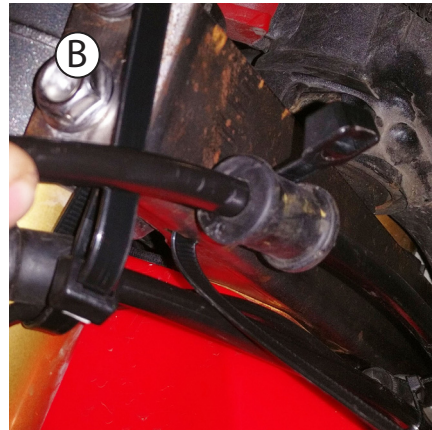
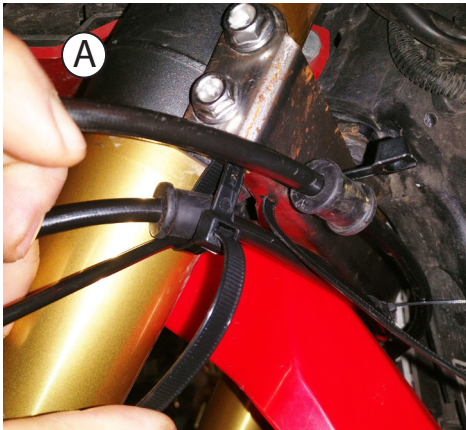

- ②6 Check fit and position of the crossover hose from right caliper, over the back side of the fender, and down to the left caliper. Slide the rubber grommets into place. Align both banjos to mate with caliper, do not twist the hose while routing over the fender and behind the lower triple tree. (A) Secure the brake line that leaves brake block to the left-most zip tie on fender bracket at grommet, leave loose. (B) Secure crossover hose to inner-left zip tie on fender bracket at grommet, leave loose.



REFERENCE: This photo was taken from underneath without the fender attached. Be sure to route your lines the same as shown.

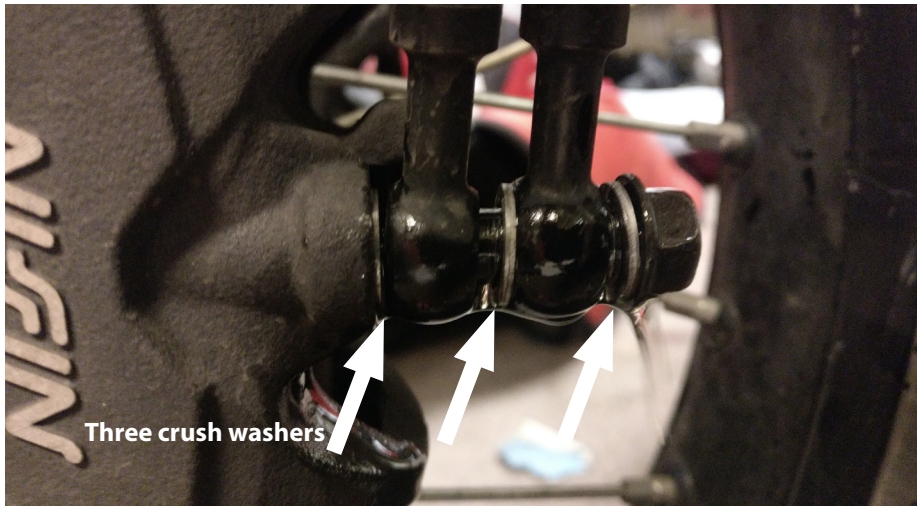

Three crush washers

- ②7 Attach brake hoses to the left side caliper.  
**Standard Africa Twin:** Use the longer of the Honda banjo bolts and three new crush washers, arrange as shown. Insert finger tight for now.  
**Adventure Sports model:** Use the AltRider provided double banjo bolt (this replaces the original banjo bolt for the left side) and three new crush washers, arrange as shown. Insert finger tight for now.



- ②8 Make sure the ABS line is routed as shown. Arrange both banjos pointing straight up. Tighten the left banjo bolt to 17-20 Nm. If there are leaks during bleeding, tighten another 1/8 turn.

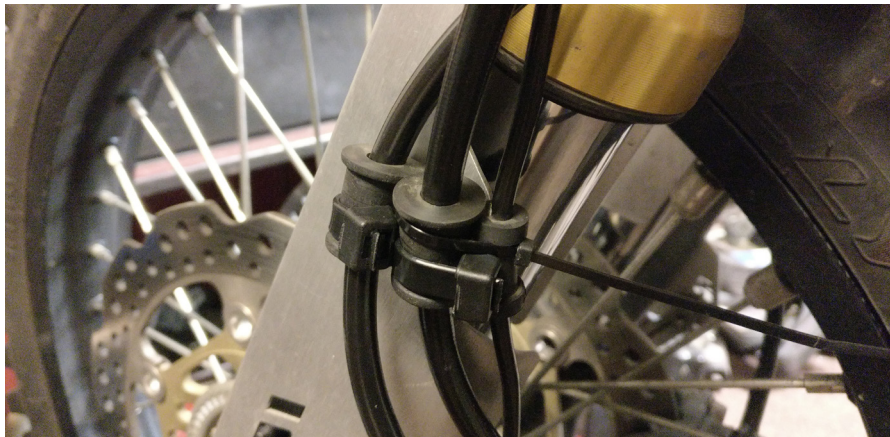

- ②9 Tighten zip-ties on left fork leg guard with brake line from brake-block in front zip tie, then crossover in second brake line in second zip tie. Attach the ABS line to crossover brake line with smaller zip tie as shown. Tighten zip-ties on fender bracket.



- ③0 Use safety wire or tape to hold the open end banjo of the right side caliper up in the air. Hold this at a height as close to the same height as the master cylinder as possible.



- ③1 Remove master cylinder reservoir cap and rubber diaphragm. Set aside on a clean surface for reinstallation later. Squeeze lever several times to pump fluid into the empty brake hoses. Keep adding new fluid to the reservoir so that the level never falls too low (which would allow air to be sucked into the system).

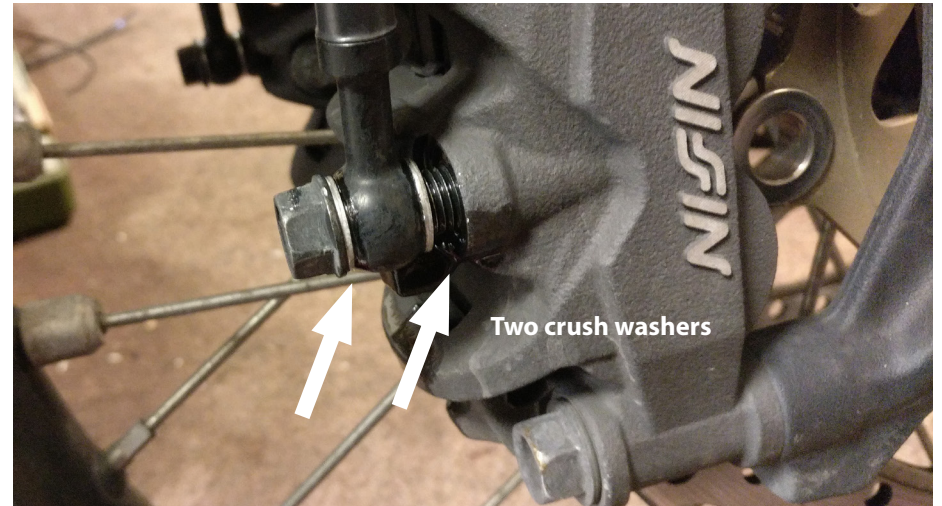

- ③2 Watch carefully for fluid to appear at the open banjo end. When this does, insert the banjo bolt with two new crush washers as shown (one on either side of the banjo).



- ③3 Quickly move the banjo down to the right caliper and screw in the banjo bolt to stop fluid leaking out. Aim banjo upward and tighten to 17-20 Nm, if there are leaks tighten another 1/8 turn.



- ③4 Bleed brakes in accordance with your manual. TIP: remember to always have the bleed hose routed upwards from the bleeder nipple, this works best to see bubbles and prevent air from being sucked back into the caliper.



- 35 Reinstall master cylinder reservoir cover and diaphragm. Clean areas with spilled fluid. Secure crossover hose at rubber grommet to the far right zip tie on fender bracket.



- 36 Operate brakes several times to be sure the bleed is good. Check to be sure there are no leaks in the system.



- 37 Move the fork fully left to right while observing the brake hoses. Be sure there is no interference, pinching, or rubbing that will create a wear spot over time. If you have any accessories installed be sure there is no interference. When suspension is compressed brake lines should bow outward, as shown, not inward or towards the back of bike.



- 38 Trim all nylon cable ties. Periodically check the torque of installed screws and inspect the brake lines and orientation of brake lines.

## CONGRATULATIONS!

**You've completed your installation. If at any point you have questions about your installation or have any feed back for us, we'd love to hear it. A downloadable version of these instructions can be found at our web site. [www.AltRider.com](http://www.AltRider.com)**

**After 5 hours of riding, or 100 miles, check all the fasteners on the assembly to ensure they are tightened to spec.**

### Global Office:

**email: info@AltRider.com**  
**phone: +1 206-922-3618**  
**address: 4000 Aurora Ave N**  
**Ste 100**  
**Seattle, WA 98103**

### Europe Office:

**email: info@AltRider.eu**  
**address: AltRider EU**  
**Heliumstraat 230**  
**2718 RS Zoetermeer**  
**The Netherlands**

#### TERMS OF USE, WARRANTY AND LIABILITY WAIVER

AltRider LLC, a Washington company, having its principal place of business in Seattle, WA ("AltRider") offers its motorcycle accessories (the "Product") with the terms, conditions and notices as follows:

##### Terms of Use

This Product is offered to you conditioned upon your acceptance without modification of the terms, conditions, and notices contained herein. Installation and/or use of this product implies acceptance of all such terms, conditions, and notices. If you do not agree to these terms, do not buy the Product. If you have already bought the Product and do not agree to these terms, return this Product promptly including the packaging and all written materials, to AltRider.

##### Limitation of Liability and Warranty Disclaimer

You may return your merchandise for a full refund or exchange, less any original or return shipping fees under these conditions:

1. Only if the merchandise is in 100% factory condition. Original manufacturer's packaging and same condition as sold – original boxes, packaging material, instructions, documentation, parts, and attached tags.
2. Only unused, unscratched, uninstalled, undamaged merchandise will be accepted. Do not install equipment until you are sure you want to keep it. Package items carefully in protective materials before returning them. Never ship an item in its original manufacturers packaging – it will arrive damaged. Please use a postal box or other adequate packaging to ensure your return or exchange is not damaged on the way back to AltRider.com.

To read more about our exchanges and returns policy, on the web, navigate to <http://www.alt rider.com/info/exchangesAndReturns>

Excepting the warranties stated in the preceding paragraph, AltRider hereby disclaims all other warranties and conditions with regard to the Product including all implied warranties and conditions of merchantability and fitness for a particular purpose. There are no warranties which extend beyond the description on the face hereof. AltRider does not warrant against damages or defects arising out of use or installation of the Product. Installation instructions are provided for your convenience. AltRider is not responsible for any damages arising out of the installation, improper or otherwise, of the Product. No warranty of any kind, expressed or implied, is made regarding the safety of this Product.

To the extent allowed by law, AltRider shall not be held liable for any direct, indirect, punitive, incidental, special or consequential damages arising out of, or connected with, the use or misuse of this Product. Buyer assumes all risks and liability arising from use of this Product.

##### Entire Agreement

This document states the entire obligation of AltRider with respect to the Product. If any part of this agreement is determined to be void, invalid, unenforceable or illegal, including, but not limited to the warranty disclaimers and liability limitations set forth above, then the remainder of the agreement shall remain in full force and effect.

##### Applicable Law

This agreement is governed by the laws of Washington, USA. You hereby consent to the exclusive jurisdiction and venue of the courts of Washington, USA, in all disputes arising out of or relating to the use of this product.

