

Item number: **BC.WPB.00.021.20000**Revision: **00** · Date: **05 - 2023****Drybag 700 tail bag** ~ 0.5 h.EASY      DIFFICULT

ENGLISH Thank you for choosing this premium product from SW-MOTECH. Visit our online shop for more information (e.g. model assignments). Required documents (e.g. national type approval) are available there for you to download.

Please read and understand all the instructions, safety information and warnings in these mounting instructions before mounting and using the product in order to avoid injury and damage. Keep these mounting instructions for reference.

This product was developed for vehicles in factory condition. Compatibility with original accessories or accessories from other manufacturers cannot be guaranteed.

These mounting instructions have been prepared to the best of our current knowledge. No legal claims relating to accuracy can be made. Errors and omissions excepted. We reserve the right to make technical and design changes. The copyright is held by SW-MOTECH.

SAFETY WARNING SYMBOL

 This warning symbol is used in these mounting instructions to warn of deadly dangers, injuries or other hazards. The words **DANGER**, **WARNING** or **CAUTION** are used as part of this warning symbol to convey important safety messages and information relating to the installation and use of this product. These words, together with the safety warning symbol, mean:

 **DANGER:** Indicates a hazardous situation which, if not avoided, will result in death or serious injury!

 **WARNING:** Indicates a hazardous situation which, if not avoided, may result in death or serious injury!

 **CAUTION:** Indicates a hazardous situation which, if not avoided, may result in minor or moderate injury!

 **NOTE:** Important information, but not relating to a risk of death or injury (property damage only)!

GENERAL INFORMATION

 **WARNING:** Assembly and/or maintenance of this product requires advanced technical skill, appropriate tools, and a good understanding of tool usage and torque specifications. For your own safety, SW-MOTECH recommends having the assembly and/or maintenance carried out by a qualified and certified motorcycle workshop.

 **WARNING:** If you do choose to assemble this product yourself, carefully and fully read the mounting instructions before assembly and use, and follow all instructions to avoid serious injury or death. Also observe all relevant information in the vehicle manual when mounting or using the product. IF YOU DO NOT UNDERSTAND ANY PART OF THESE MOUNTING INSTRUCTIONS OR NEED AN EXPLANATION AS TO A SPECIFIC INSTRUCTION, DO NOT ATTEMPT TO INSTALL THIS PRODUCT WITHOUT CONSULTING SW-MOTECH FOR ASSISTANCE!

PREPARATION: Read the mounting instructions carefully and make sure that all parts on the parts list are available.

 **CAUTION:** Ensure that your vehicle is standing securely. Switch off the engine and remove the ignition key. Allow the engine/exhaust to cool down if necessary. Disconnect the battery when working on the electrical system. Only use proper tools and always wear safety goggles and gloves during assembly and maintenance. Have a second person help you with assembly and maintenance.

ASSEMBLY: All parts and connections removed from the vehicle must be reinstalled according to the vehicle manufacturer's specifications or replaced with parts and hardware supplied by SW-MOTECH.

 **WARNING:** Secure all threads with a medium-strength liquid threadlocker, unless otherwise specified.

 **DANGER:** Tightening torques not defined by SW-MOTECH must be obtained from the vehicle manufacturer or a certified motorbike workshop.

FUNCTIONAL CHECK: After mounting the product, ensure that no moving parts are obstructed and that the function of the vehicle is not impeded. Cables and hoses must not rub against each other and/or be hindered in any way.

 **WARNING:** Carry out a comprehensive functionality check before you start to drive. Check the tightening torque of all connections and the tight fit of the product after the first 50 km and then at regular intervals. Mounted accessories can change the handling and stability of the vehicle.



SW-MOTECH GmbH & Co. KG
Ernteweg 7-10
35282 Rauschenberg
Germany



 info@sw-motech.com
 www.sw-motech.com



Take note of the symbols and what they mean in the ASSEMBLY section. If the term OEM appears in the ASSEMBLY section, the vehicle manufacturer's specifications must be observed and applied.



If you have any questions, please don't hesitate to contact our Customer Service team or our distributors. You can find our telephone number and a list of our distributors in our online shop:

www.sw-motech.com

PARTS LIST - READ AND KEEP MOUNTING INSTRUCTIONS!

1

1



BC.WPB.00.021.20000

 **1/1**

2



LSF.350.250

 **1/1**

2

3



BC.ZUB.00.137.30000

 **1/1**

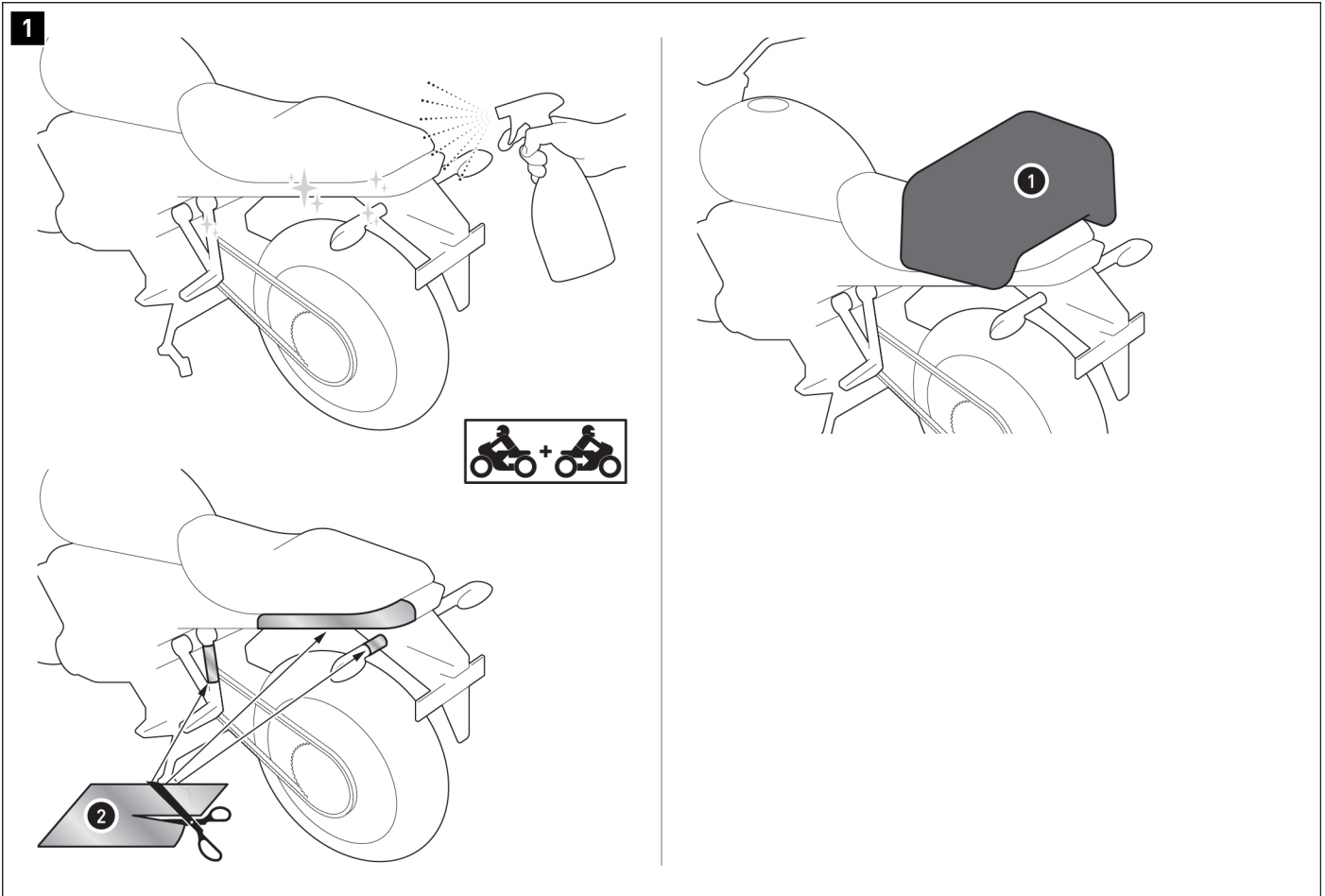

- ⚠ **WARNING:** Always wear eye and hand protection!
- ⚠ **WARNING:** Always use the proper tools!

⚠ **NOTE:** The tail bag, vehicle and attachment shown will also serve as an example in the following steps.

⚠ **NOTE:** Dirt on the product and vehicle has an abrasive effect and may damage surfaces such as the paintwork. Protect ALL surfaces of the tail bag and loop straps with the enclosed adhesive protective foil (2) to avoid damage to the paintwork and any abrasion. Thoroughly clean the respective surface to ensure it is free of grease and dirt residue before applying the adhesive protective foil. Sharp-edged corners must especially be protected! After attaching the tail bag, check whether the affected areas of the vehicle are adequately protected. SW-MOTECH is not responsible for damage to the paintwork and abrasion.

Place your tail bag (1) on the back of your vehicle.

⚠ **NOTE:** Unzip the middle zipper on your tail bag to be able to place it on wider tails.

⚠ **CAUTION:** To prevent the rain from permeating into the tail bag (1) from the headwind, align the opening in the opposite direction you are traveling in!

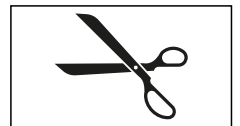

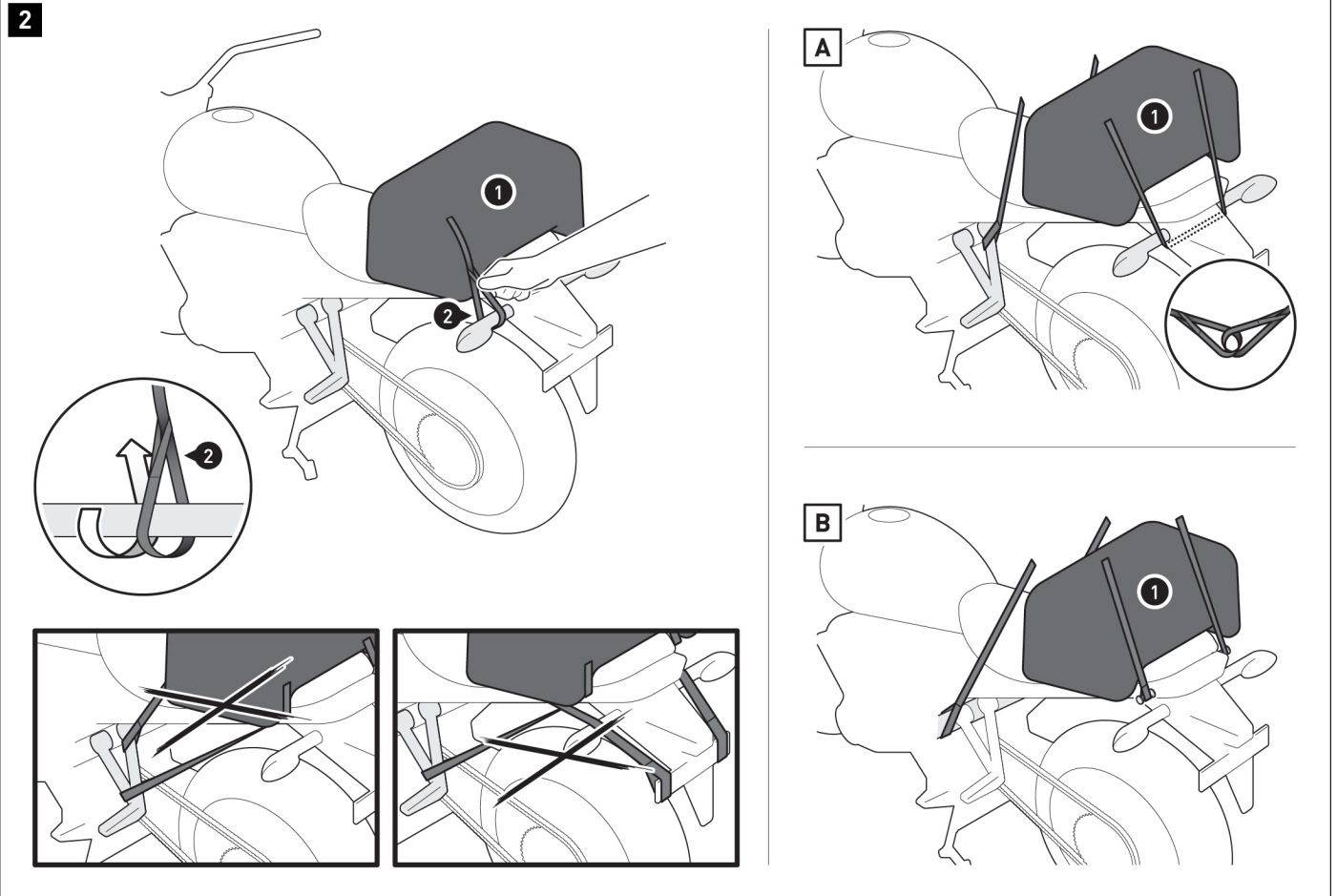



Loop the lashing straps [3] at **FOUR** suitable, sturdy attachment points on the vehicle, as shown in the drawing and examples **[A]** and **[B]** (ex. footrest mount, vehicle frame, luggage hook, etc.). Be sure to attach the appropriate lashing strap to the attachment points (male to female; female to male) for the buckles on the bag.

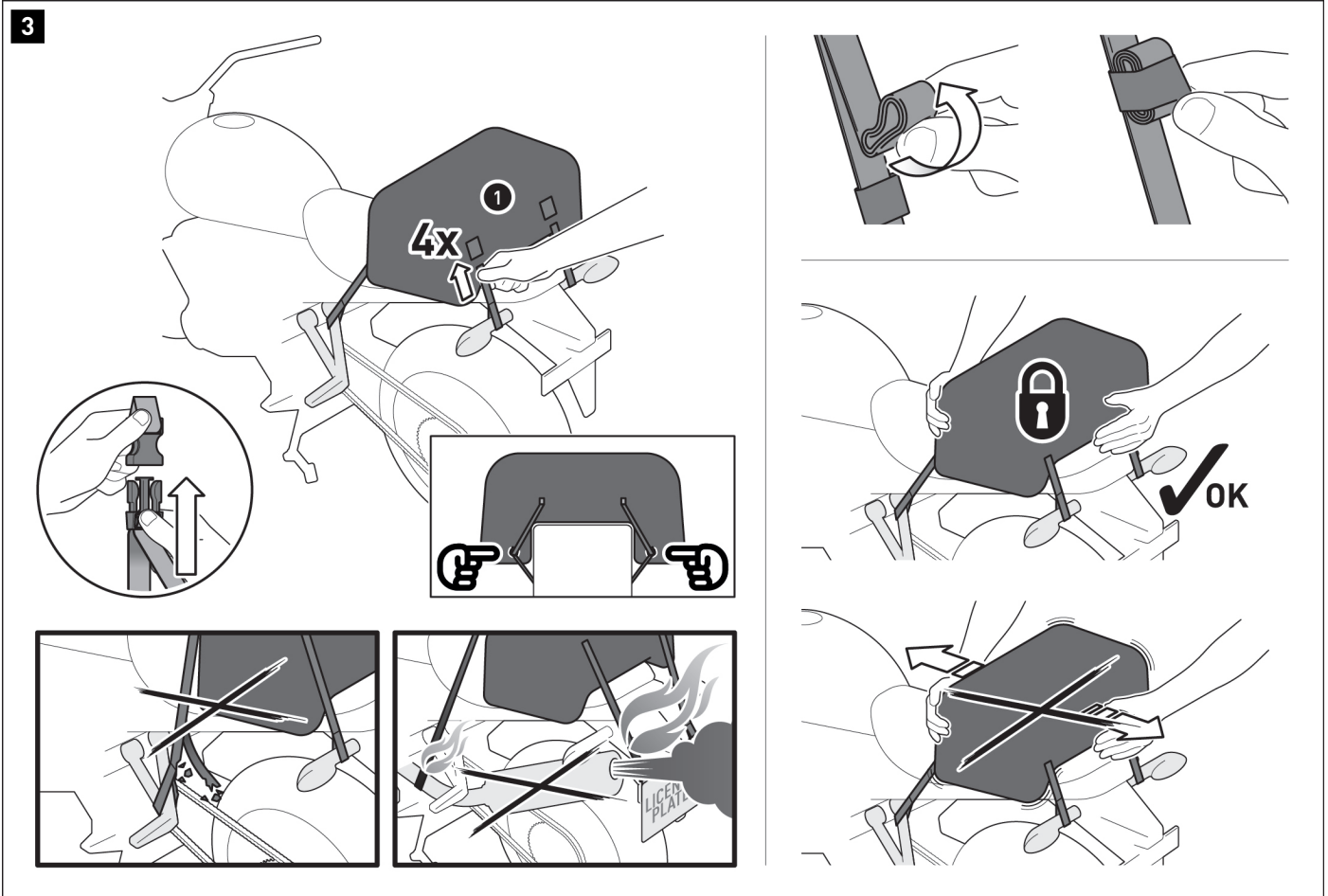

▲ WARNING: The attachment points must be selected in such a way that the tail bag (1) will not slip! To do so, clamp the tail bag (1) forwards to the two front attachment points and backwards to the two rear attachment points!



Connect the lashing straps (3) to the tail bag (1). Then tighten the lashing straps (3).

OPTIONAL: Guide the lashing straps (3) on both sides through the loops attached to the bottom of the tail bag (1) (see markings ) to improve the fit of the tail bag (1).

▲ DANGER: Ensure that no component of the tail bag can come into contact with hot or moving parts of the vehicle! Ensure that all components are at least 5 cm away from hot parts and the hot exhaust flow! To verify, thoroughly bounce the vehicle several times after mounting!

Roll up the excess lengths of the lashing straps (3) and secure them using the elastic loops.

▲ WARNING: Check that the tail bag (1) is positioned properly and securely before departure and at every rest stop (every 200 km)!

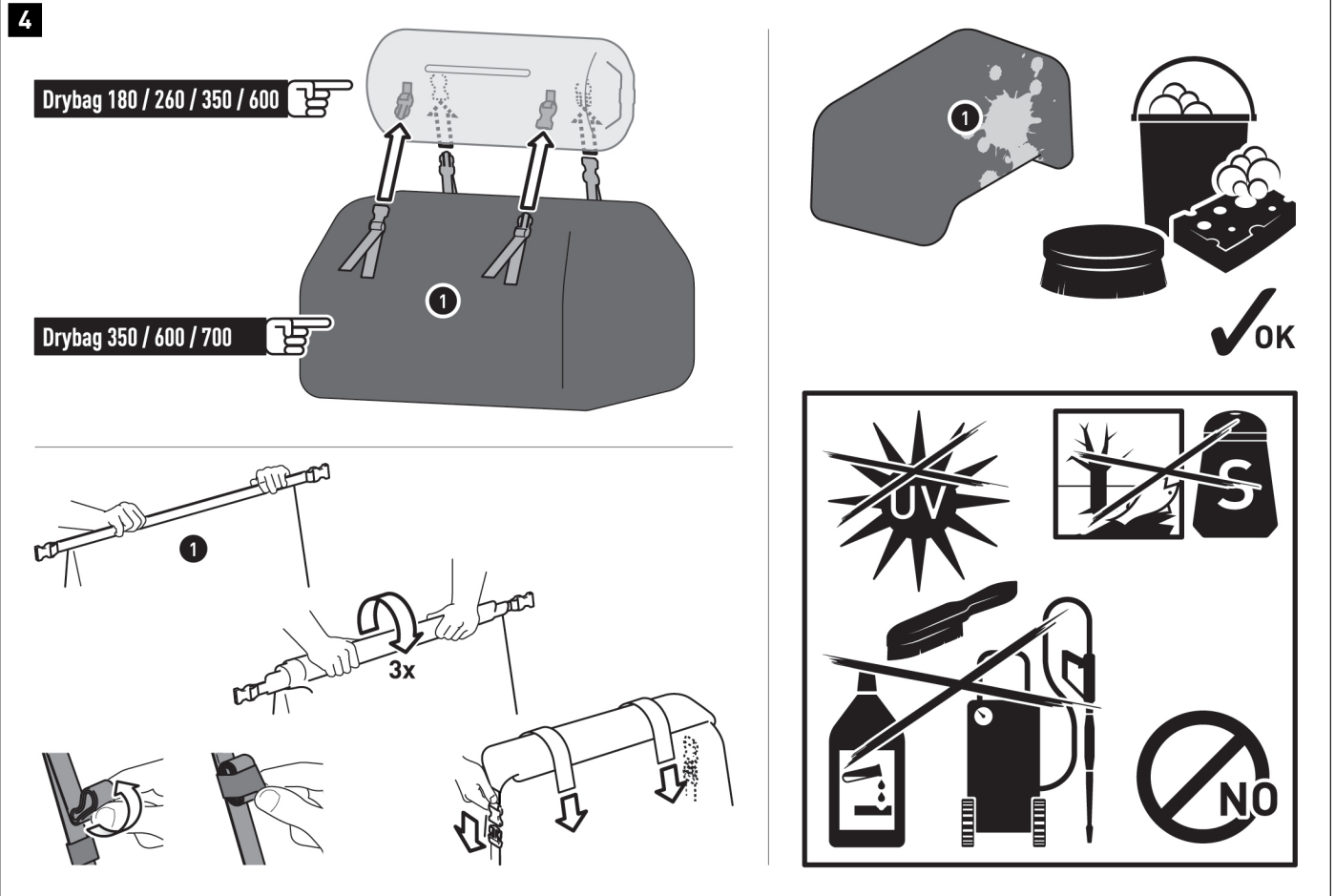

The tail bags are designed to be attached to other tail bags from the Drybag series. Connect the tail bags using the buckles (**max. TWO tail bags on top of each other per vehicle; the LOWER bag must be larger than the UPPER bag**). Then ensure that all buckles are correctly positioned and securely held.

Close the tail bag (1) as shown. To do so, roll the opening three times and close it with the buckles. Roll up the excess lengths of the buckle straps and secure them with the elastic loops.

If no second bag is used: additionally secure the opening with the sewn-on buckle straps. To do so, simply connect the buckle straps over the closed opening, pull tight, roll up any excess and secure it to the straps with the Velcro straps (Drybag 350/600/700 only).

⚠ NOTE: Select SW-MOTECH products can be looped onto the attached MOLLE attachments (only Drybag 350/600/700)!

LOADING

⚠ WARNING: Never store sharp-edged, pointed or similar objects!

⚠ DANGER: MAXIMUM LOAD: 12 kg (26 lbs)!

CARE

⚠ CAUTION: Use **ONLY** a soft fabric brush, cloth or sponge and some warm soapy water when cleaning!
Then rinse with clean water.

Do **NOT** use any harsh cleaning agents, abrasive cleaning utensils or pressure washer!

Be sure to clean the product after winter driving to avoid salt damage.

⚠ NOTE: Surface materials can be subject to color changes (fading) in the event of prolonged and intensive exposure to sunlight and weather conditions (e.g. smog, acid rain, etc.)! SW-MOTECH is not responsible for this sort of wear.

PRODUCT-SPECIFIC NOTES

⚠ NOTE: Observe the country-specific regulations for registering/operating your vehicle or the applicable TÜV regulations. After assembly, have parts that are subject to registration entered in the vehicle documents by your test centre.

⚠ DANGER: Since this is a universal product, please make sure that the product can be attached and used properly and seamlessly on your vehicle type BEFORE using it for the first time! After attaching, check that all vehicle parts can move freely and function properly! Lamps such as taillights and turn light indicators must not be impeded in their function! Cables, wires and hoses should not rub and/or squeeze against anything!

⚠ DANGER: Carry out a comprehensive function check before driving!

⚠ DANGER: Check that the product is properly positioned before departure and at every rest stop (every 200 km)!

⚠ DANGER: The driving/braking behavior of the motorcycle changes noticeably after the attachment of this product!

⚠ DANGER: Lean angle and ground clearance may be restricted by this product!

⚠ DANGER: The maximum vehicle load specified by the vehicle manufacturer is applicable!

	see LOAD		≤ 130km/h (≤ 80mph)
---	----------	---	---------------------