

Performance Damper NMAX

B6H-211H0-**



00:30



Posnr.	QTY	
①	1	
②	1	
③	1	
④	1	

Posnr.	QTY	
⑤	1	
⑥	1	
⑦	1	
	1	
	1	
⑧	1	
⑨	2	
⑩	1	
⑪	2	
⑫	1	
⑬	1	
⑭	1	

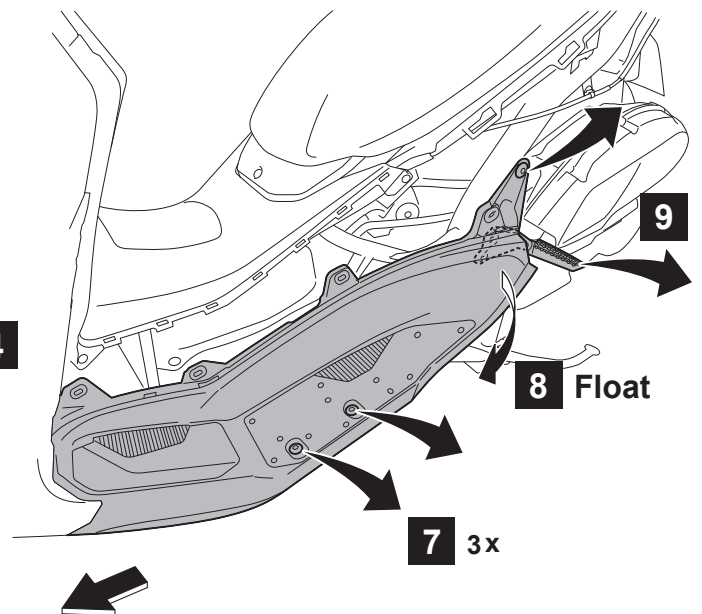
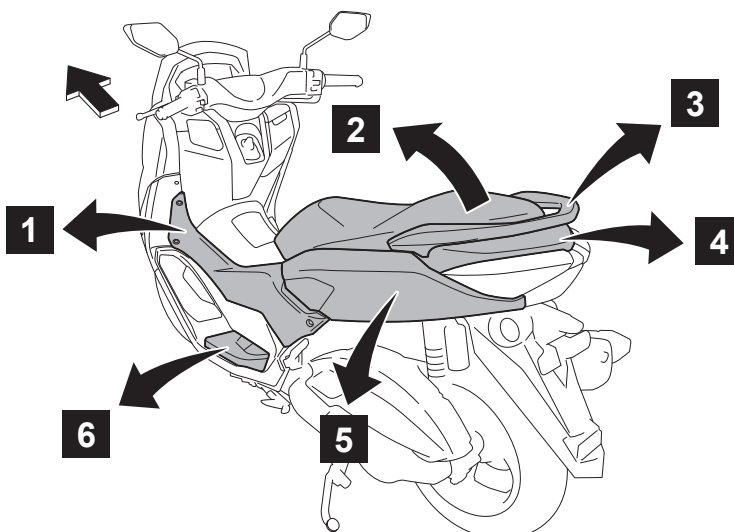
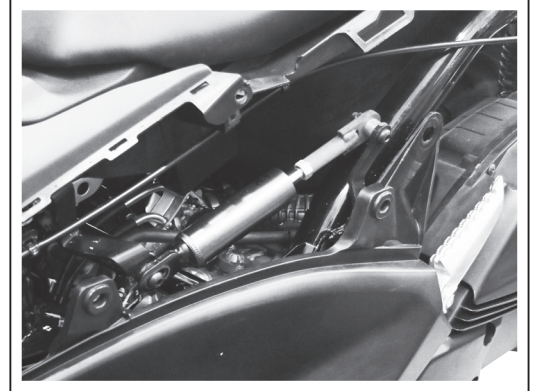

Easy, suitable for novice with little experience



Fairly easy, suitable for beginner with some experience



Fairly difficult, suitable for competent DIY mechanic



Difficult, suitable for experienced DIY mechanic



Very difficult, suitable for expert DIY or professional



Performance Damper NMAX

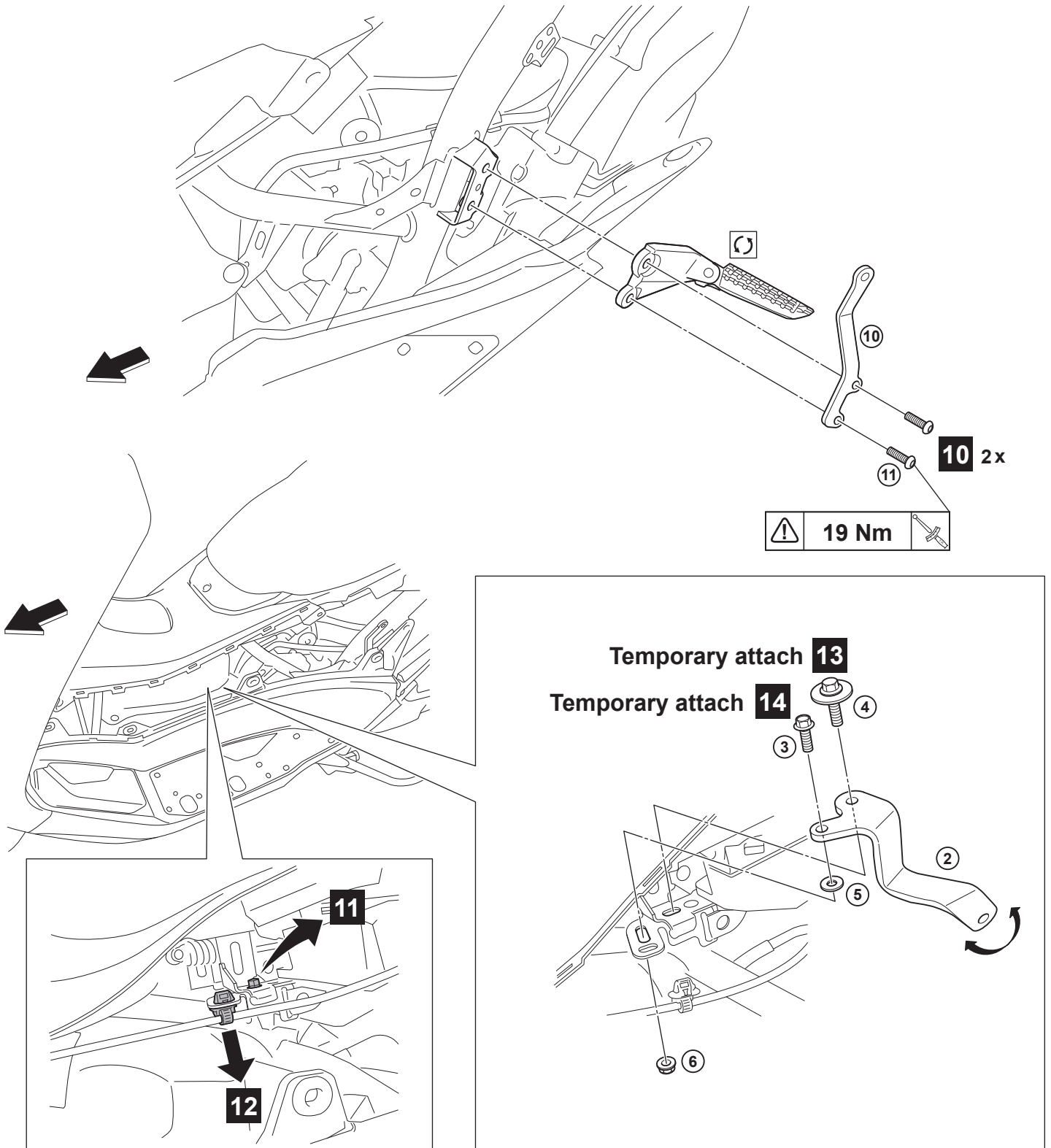

Performance Damper NMAX

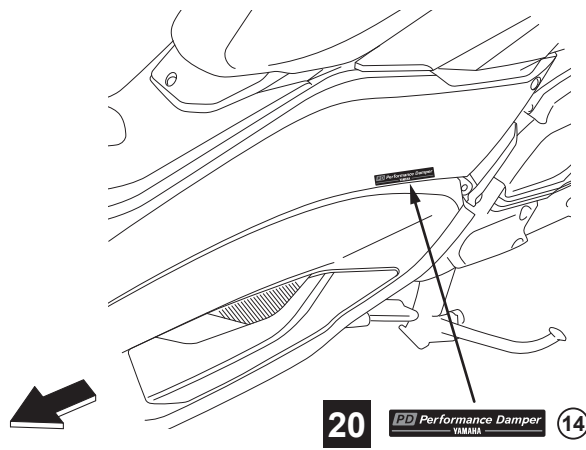
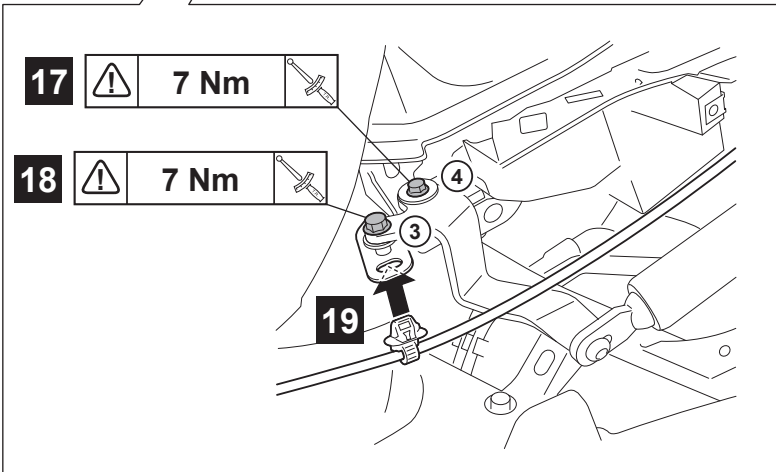
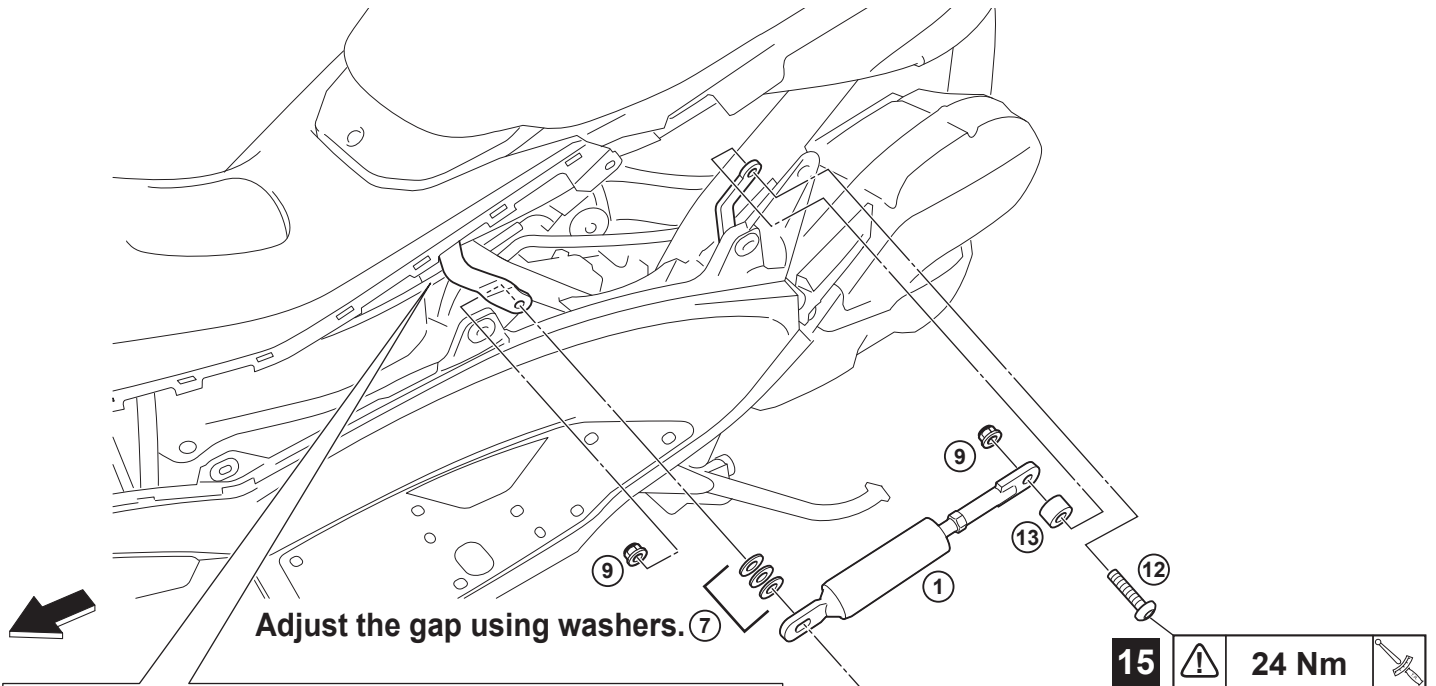

✗ Do not dent the cylinder

✗ Do not expand or contract
✗ Do not rotate the rod

